

EPA Est. 99918-CHN-1

CONGRATULATIONS

You've purchased a series T UVC Essential Tower that will help you sanitize hard surfaces.

Please read these instructions thoroughly before operating the unit. If you have any questions, please contact our Customer Experience team at 425.595.6330, or support@safeology.com

APPLICATION

These installation instructions apply only to Ultraviolet – C (UVC) towers sold by Electric Mirror. Referred to as 'the tower' throughout this operation manual.

TABLE OF CONTENTS

1. SAFETY INSTRUCTIONS	2
2. UNPACK YOUR UVC TOWER.....	5
3. INSTALL THE LAMPS AND CONNECT TO POWER	5
4. SAFETY FEATURES	6
5. OPERATING INSTRUCTIONS	7
6. CARE AND CLEANING INSTRUCTIONS.....	8

1. SAFETY INSTRUCTIONS



A. No electrician required.

- I. This unit is operated by a standard 120V type B Grounded Plug and does not require special electrical connections.

B. Read and follow instructions.

- I. For proper operation, read and operate the tower according to these instructions, and keep a copy for future use.
- II. Failure to follow these instructions voids the warranty.
- III. Do not use this product for other than it's intended use.

A. Follow safety precautions.

- I. Follow safety precautions. To prevent injury, the mobile purifier must be operated according to these instructions. Failure to do so could result in serious injury or death.
- II. This unit uses UVC lighting. Do not look at the lamps while operating.
- III. Turn off all power before servicing.

B. Mercury lamp disposal and clean up.

- I. If a lamp breaks, please follow instructions found here:
<https://www.epa.gov/cfl/cleaning-broken-cfl>
- II. See the following website for disposal information:
<https://www.epa.gov/cfl/recycling-and-disposal-cfls-and-other-bulbs-contain-mercury#wherecycle>



CAUTION UVC RADIATION HAZARD

IMPORTANT SAFETY INSTRUCTIONS

- READ AND FOLLOW ALL SAFETY INSTRUCTIONS
- FOLLOW NATIONAL ELECTRIC CODE DURING INSTALLATION
- INSTALLATION BY QUALIFIED PERSONNEL ONLY
- WARNING: RISK OF ELECTRICAL SHOCK
- FIXTURE MUST BE GROUNDED
- TURN OFF POWER AT BREAKER BEFORE INSTALLATION OR SERVICING
- SAVE THESE INSTRUCTIONS

IMPORTANT SAFEGUARDS

When using electrical equipment, basic safety precautions should always be followed including the following:

READ AND FOLLOW ALL SAFETY INSTRUCTIONS

- a) This equipment is designed for use with germicidal UV radiation sources and must be installed in compliance with competent technical directions to prevent risk of personal injury from UV radiation.
- b) UV radiation can pose a risk of personal injury. Overexposure can result in damage to eyes and bare skin. To reduce the risk of overexposure this equipment must be installed in accordance with the manufacturer's site planning recommendations. This may include instructions on the relative location of each germicidal system component, the minimum distances between UV-generating devices and other objects or surfaces, and protection from line-of-sight exposure to UV radiation in occupied spaces located above the equipment mounting area (e.g. upper floor balconies, open staircases, etc.
- c) UV and optical radiation can be reflected by surrounding surfaces such as ceilings and walls. Since the reflective properties of surfaces can vary widely, it should be considered as part of site planning. Follow the manufacturer's recommendations for selecting appropriate ceiling and wall finishes.
- d) IT IS THE RESPONSIBILITY OF THE INSTALLER TO ENSURE THAT PERSONS WILL NOT BE EXPOSED TO EXCESSIVE UV OR OPTICAL RADIATION DURING EQUIPMENT OPERATION. THIS WILL REQUIRE THE INSTALLER TO CONDUCT AN ASSESSMENT OF IRRADIANCE LEVELS IN THE SURROUNDING OCCUPIED SPACES PRIOR TO OCCUPANCY.
- e) Equipment should be mounted in locations and at heights where it will not readily be subjected to tampering by unauthorized personnel.
- f) Maintenance and servicing of this UV generating equipment shall be performed by authorized personnel. Service personnel must wear appropriate Personal Protective Equipment (PPE) if the equipment will be in separation during the maintenance or servicing work. Contact the equipment manufacturer for PPE recommendations and guidance.
- g) When replacing lamps, replace them only with the lamps for which the equipment is marked and intended.
- h) The use of accessory equipment not recommended by the manufacturer may cause an unsafe condition.
- i) Do not use this equipment for other than intended use.

SAVE THESE INSTRUCTIONS

UVC radiation can cause severe eye and skin damage. Never look directly at lamp while on. Always turn product off before lamp replacement. Fixture must be installed and operated in strict accordance with these instructions.



ATTENTION RISQUE DE RAYONNEMENT UVC

CONSIGNES DE SÉCURITÉ IMPORTANTES

- LISEZ ET SUIVEZ TOUTES LES CONSIGNES DE SÉCURITÉ
- SUIVEZ LE CODE ÉLECTRIQUE NATIONAL PENDANT L'INSTALLATION
- INSTALLATION PAR UN PERSONNEL QUALIFIÉ UNIQUEMENT
- AVERTISSEMENT: RISQUE DE CHOC ÉLECTRIQUE
- L'APPAREIL DOIT ÊTRE MIS À LA TERRE
- COUPEZ L'ALIMENTATION AU DISJONCTEUR AVANT L'INSTALLATION OU L'ENTRETIEN
- CONSERVEZ CES INSTRUCTIONS
- AVERTISSEMENT: NE CONVIENT PAS À UNE UTILISATION AVEC DES CONTRÔLES DE VITESSE À ÉTAT SOLIDE

GARANTIES IMPORTANTES

Lors de l'utilisation d'équipements électriques, des précautions de sécurité de base doivent toujours être suivies, notamment les suivantes:

LISEZ ET SUIVEZ TOUTES LES CONSIGNES DE SÉCURITÉ

- a) Cet équipement est conçu pour être utilisé avec des sources de rayonnement UV germicides et doit être installé conformément aux instructions techniques compétentes pour éviter tout risque de blessure par les rayons UV.
- b) Le rayonnement UV peut présenter un risque de blessure corporelle. Une surexposition peut endommager les yeux et la peau nue. Pour réduire le risque de surexposition, cet équipement doit être installé conformément aux recommandations de planification du site du fabricant. Cela peut inclure des instructions sur l'emplacement relatif de chaque composant du système germicide, les distances minimales entre les dispositifs générateurs d'UV et d'autres objets ou surfaces, et la protection contre l'exposition en visibilité directe aux rayons UV dans les espaces occupés situés au-dessus de la zone de montage de l'équipement (par exemple, balcons à l'étage supérieur, escaliers ouverts, etc.
- c) Les rayons UV et optiques peuvent être réfléchis par les surfaces environnantes telles que les plafonds et les murs. Étant donné que les propriétés réfléchissantes des surfaces peuvent varier considérablement, elles doivent être prises en compte dans le cadre de la planification du site. Suivez les recommandations du fabricant pour sélectionner les finitions de plafond et de mur appropriées.
- d) IL EST DE LA RESPONSABILITÉ DE L'INSTALLATEUR DE S'ASSURER QUE LES PERSONNES NE SERONT PAS EXPOSÉES À DES RADIATIONS UV OU OPTIQUES EXCESSIVES PENDANT LE FONCTIONNEMENT DE L'ÉQUIPEMENT. CELA EXIGERA L'INSTALLATEUR DE PROCÉDER À UNE ÉVALUATION DES NIVEAUX D'IRRADIANCE DANS LES ESPACES OCCUPÉS ENVIRONNANTS AVANT L'OCCUPATION.
- e) L'équipement doit être installé dans des endroits et à des hauteurs où il ne sera pas facilement soumis à une altération par du personnel non autorisé.
- f) La maintenance et l'entretien de cet équipement générant des UV doivent être effectués par du personnel autorisé. Le personnel d'entretien doit porter un équipement de protection individuelle (EPI) approprié si l'équipement doit être séparé pendant les travaux d'entretien ou de réparation. Contactez le fabricant de l'équipement pour obtenir des recommandations et des conseils sur l'EPI.
- g) Lors du remplacement des lampes, remplacez-les uniquement par les lampes pour lesquelles l'équipement est marqué et conçu.
- h) L'utilisation d'équipements accessoires non recommandés par le fabricant peut entraîner une situation dangereuse.
- i) N'utilisez pas cet équipement à d'autres fins que celles pour lesquelles il a été conçu.

CONSERVEZ CES INSTRUCTIONS

Le rayonnement UVC peut provoquer de graves lésions oculaires et cutanées. Ne regardez jamais directement la lampe lorsqu'elle est allumée. Éteignez toujours le produit avant de remplacer la lampe. L'appareil doit être installé et utilisé en stricte conformité avec ces instructions. Appareil fonctionnant selon les directives du fabricant.

2. UNPACK YOUR UVC TOWER

A. Verify the contents.

Unpack the box, identify, and verify all contents prior to installation. In general, your tower will include the following:

UVC Tower

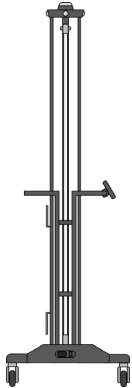

UVC Lamps

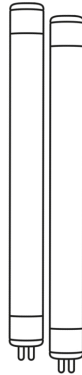

Power Cord

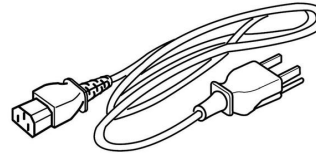

Dust Cover

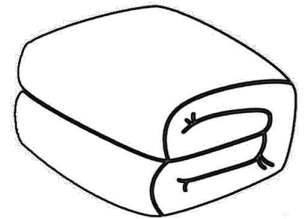

3. INSTALL THE LAMPS AND CONNECT TO POWER

A. Lamp connectors are in the bottom of the tower.

- I. Remove the dust cover from the tower.
- II. Gently pass the lamp over the handrailing.
- III. Lower the end with pins into the lamp holder at the bottom of the tower, ensuring the lamp is fully seated in the holder.
- IV. Secure the capped end of the lamp into the clip at the top of the tower.
- V. Repeat for the additional lamp.
- VI. Follow prescribed cleaning instructions once lamps are installed (see 6C).

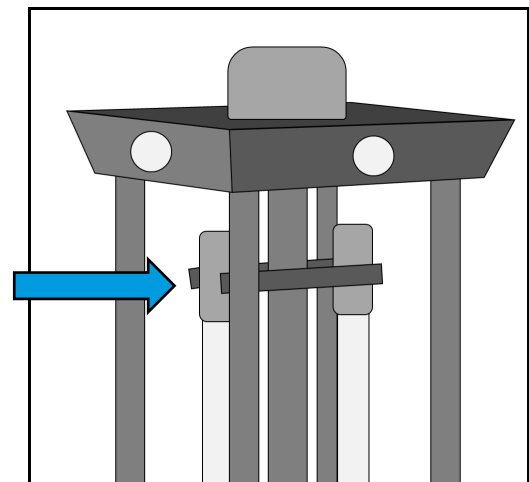
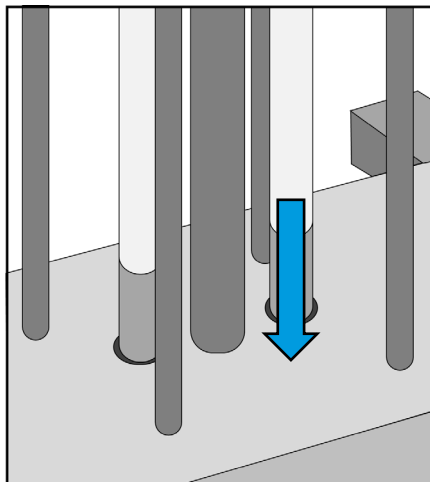

B. Connect power cord and turn on master power.

- I. Locate the female end of the power cord and insert into the receiver at the base of the tower.
- II. Unspool the cable and plug the male end of the cord into a wall socket.
- III. Turn on master power by moving the switch at the base of the tower to the 'on' position.

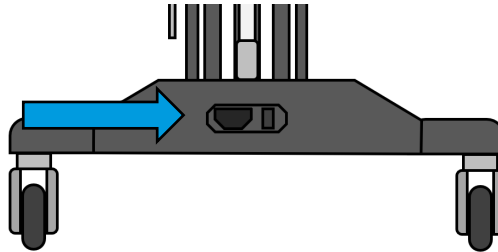

4. SAFETY FEATURES

A. There is an auto-delay of 60 seconds after activation of tower.

- I. The auto-delay will appear on the display panel located on the tower rail.
- II. The light on the top of the tower will blink once the countdown begins.
- III. An audible buzzer will sound.
 - a. Once a second for the first 50 seconds.
 - b. Twice per seconds over the last 10 seconds.
- IV. Operator should vacate the space once the light and buzzer are activated.

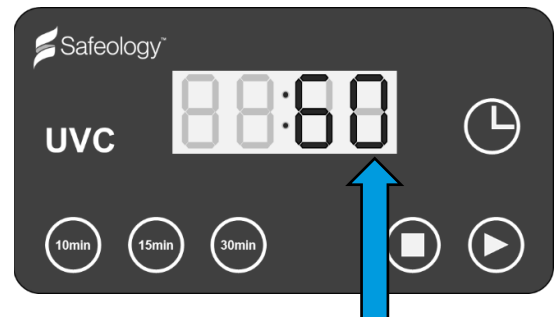
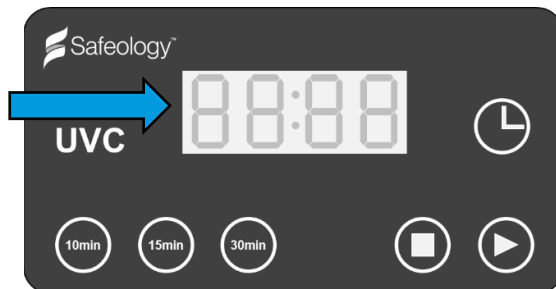

B. Cycle completion.

- I. Once the disinfection is complete the audible alarm will sound every 3 seconds until the stop  button is pressed.

C. Additional Safety features.

- I. The lamp has four PIR sensors to detect movement within 16' of the tower.
 - a. The tower will switch off automatically and activates the warning light and audible alarm.
 - b. The audible alarm will beep once per second until the area is clear again.
 - c. The program will restart with the 60 second count down as described above.
- II. The tower has a tilt sensor that will automatically deactivate the tower if the tower leans by 45° or more.
- III. The tower will deactivate if it detects broken lamps.

5. OPERATING INSTRUCTIONS

A. Using pre-programed disinfection cycles.

- I. There are three pre-programmed cycle times.
 - a. 10 minutes.
 - b. 15 minutes.
 - c. 30 minutes.
- II. Select one of the pre-programmed buttons.
 - a. The duration selected will appear on the display panel.
 - b. Press the start button. 
 - c. The programmed duration will be temporarily replaced by the countdown clock as described in 4A.
 - d. Thereafter, the display will present the time remaining in the disinfection cycle.

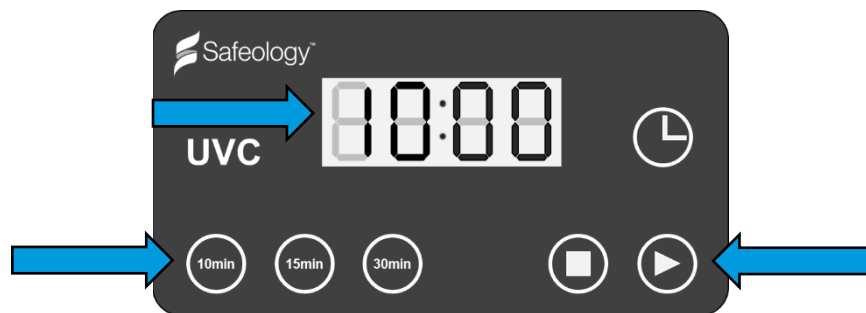

B. Using custom disinfection cycles.

- I. Select the pre-programmed button closest, but less than desired time.
 - a. If the desired time is less than 10 minutes, skip to 5B.II.
- II. Use the clock button to advance the timer by 1 minute per touch. 
- III. The custom program time will appear on the display.
- IV. Press the start button to activate the custom program.
 - a. The programmed time will be replaced temporarily as in 5A.IIc.
 - b. Thereafter, the display will present the time remaining in the disinfection cycle.

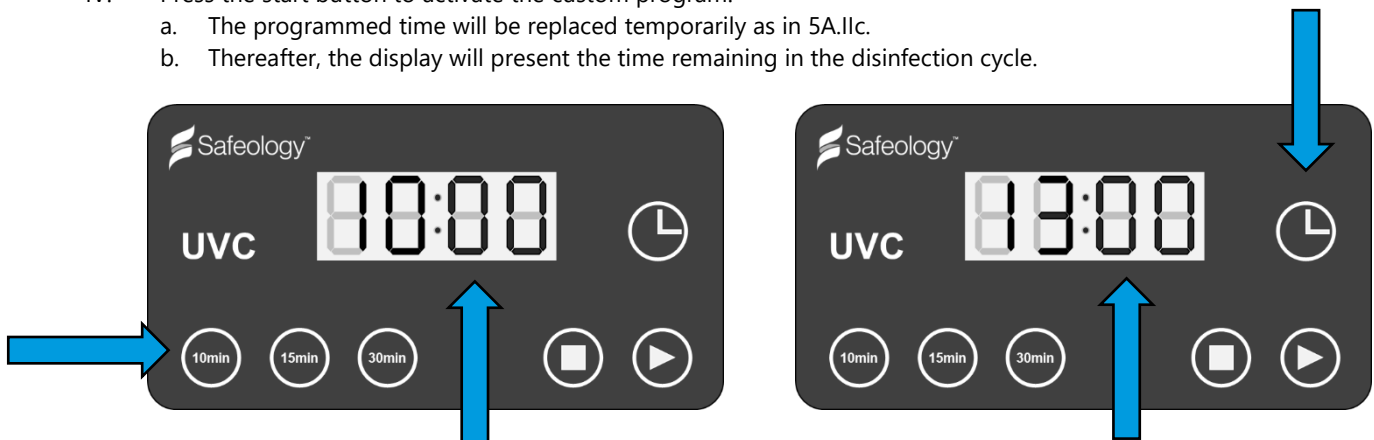

C. The timer can be reset by selecting the stop button.

6. CARE AND CLEANING INSTRUCTIONS

Failure to follow the below will void the warranty.

- A. **Always unplug the unit from the wall before servicing.**
- B. **Use soft, grit-free and lint-free cloths to reduce the chance of scratching.**
- C. **Never spray water or cleaner directly onto the unit.**
 - I. Instead, apply it directly to the cloth, then wipe.
 - II. Ensure everything is thoroughly dry.
- D. **Lamps.**
 - I. Should be cleaned every 3 months.
 - a. Apply alcohol to a rag and wipe down the lamp.
 - b. Do not use water.
 - II. Replace lamps every year or 12,000 hours of operation.
 - a. Lamp must match specification listed on label in housing.
 - b. See above for installation instructions.
- E. **Store unit with dust cover on when tower is not in use.**